

# Lessons from a gene regulatory network: echinoderm skeletogenesis provides insights into evolution, plasticity and morphogenesis

Charles A. Ettensohn

Significant new insights have emerged from the analysis of a gene regulatory network (GRN) that underlies the development of the endoskeleton of the sea urchin embryo. Comparative studies have revealed ways in which this GRN has been modified (and conserved) during echinoderm evolution, and point to mechanisms associated with the evolution of a new cell lineage. The skeletogenic GRN has also recently been used to study the long-standing problem of developmental plasticity. Other recent findings have linked this transcriptional GRN to morphoregulatory proteins that control skeletal anatomy. These new studies highlight powerful new ways in which GRNs can be used to dissect development and the evolution of morphogenesis.

## Introduction

To understand how development is encoded in the genome, biologists are turning increasingly to system-level approaches. The concept of transcriptional gene regulatory networks (GRNs) is proving to be a powerful one in this context. GRNs are ensembles of genes that encode transcription factors (TFs) and the genes that these proteins regulate. A central component of GRN analysis is the dissection of the cis-regulatory control systems of genes. Cis-regulatory systems consist of non-coding DNA sequences that control when and where genes are transcribed. They are often viewed as modular, information-processing systems (Davidson, 2006). GRN analysis attempts to identify not only the functional interactions among genes, but also the relevant cis-regulatory DNA sequences, the proteins that bind to these sequences, and the logic by which cis-regulatory systems control gene transcription.

The GRNs that operate during embryonic development (developmental GRNs) are highly dynamic. New interactions between genes are continually established as old interactions are modified or discarded. Inputs from cell signaling pathways, and intrinsic properties of regulatory networks themselves, contribute to the dynamic nature of GRNs (see Davidson, 2006). The genomic regulatory states of embryonic cells, which are a reflection of the concentrations and activities of hundreds of TFs and the global patterns of gene activity they evoke, are thus ever changing.

This review considers recent studies that have applied the GRN concept in new and informative ways to examine developmental plasticity (that is, the ability of embryonic cells to switch developmental pathways), morphogenesis, and the evolution of developmental programs. It focuses on a GRN that controls skeletogenesis in sea urchins, a group of animals belonging to the phylum Echinodermata that has proven to be particularly useful for

the analysis of GRNs in early development. GRNs that underlie cell specification are presently understood in greater detail in the sea urchin than in any other metazoan embryo, although work is ongoing in several other experimental models (Koide et al., 2005; Stathopoulos and Levine, 2005; Ge et al., 2006; Satou et al., 2008). For general reviews of GRNs in early sea urchin development, and of the methods used to construct and represent GRNs, see Oliveri and Davidson (Oliveri and Davidson, 2004) and Ben-Tabou de-Leon and Davidson (Ben-Tabou de-Leon and Davidson, 2007).

## The skeletogenic GRN in sea urchins

In the sea urchin (as in most metazoan embryos), maternal polarity entrains early patterning (Brandhorst and Klein, 2002; Angerer and Angerer, 2003). Zygotic transcription begins very soon after the egg is fertilized and reaches a maximal rate during early cleavage. By the 16-cell stage, different programs of gene expression are already deployed in the different tiers of blastomeres that are organized along the animal-vegetal (AV) axis. The late blastula is a mosaic of distinct territories, each of which is delineated by the domains of expression of many representative genes (Fig. 1). In most cases, the different territories of the blastula are not strictly associated with early cell lineage compartments and their boundaries are not rigidly fixed. GRNs are currently being developed for many of the early embryonic territories shown in Fig. 1, although their level of completeness varies.

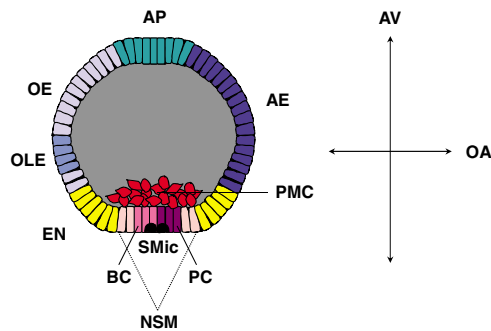
## The PMC GRN in euechinoid sea urchins: new components, new connections

At present, the best understood GRN in the sea urchin, and probably the best understood GRN in any embryo, is the network that underlies the specification and differentiation of skeletogenic cells in euechinoids. Euechinoids are the largest subclass of modern sea urchins, and this subclass includes all of those species commonly used for developmental research, including the purple sea urchin *Strongylocentrotus purpuratus*, for which a high-quality genome assembly is available (Sea Urchin Genome Consortium, 2006). Sea urchins and other echinoderms produce an elaborate endoskeleton (an internal skeleton) composed of calcite, a form of calcium carbonate (for more on skeletogenesis in different echinoderms see Box 1). The morphogenesis of the embryonic skeleton of euechinoid sea urchins has been a subject of study for many decades; in part because the skeleton is a highly ordered, beautiful structure, and because it can easily be visualized in living embryos (Wilt and Ettensohn, 2007).

The embryonic skeleton of euechinoids is produced by a specialized population of skeletogenic cells called primary mesenchyme cells, or PMCs (Fig. 2). PMCs are derived from four small cells known as micromeres, which are located at the vegetal pole of the 16-cell stage embryo. Among the echinoderms, only sea urchins produce micromeres, which are therefore considered to be a relatively recent invention (see discussion below and Box 1). Each micromere

Department of Biological Sciences, Carnegie Mellon University, 4400 Fifth Avenue, Pittsburgh, PA 15213, USA.

e-mail: ettensohn@andrew.cmu.edu



**Fig. 1. Territories of the late-blastula stage sea urchin embryo.**

The different cell territories of the embryo are shown in different colors, and the central blastocoel cavity is shaded gray. The oral-aboral (OA) and animal-vegetal (AV) axes are also shown. AE, aboral ectoderm; AP, apical plate; BC, presumptive blastocoelar cells; EN, endoderm; NSM, non-skeletogenic mesoderm; OE, oral ectoderm; OLE, oral-lateral ectoderm; PC, presumptive pigment cells; PMC, primary mesenchyme cells (skeletogenic mesoderm); SMic, small micromeres.

divides unequally, producing a large daughter cell (large micromere) that later gives rise to PMCs, and a small daughter cell (small micromere), which adopts a different fate. PMCs undergo a sequence of striking morphogenetic behaviors that includes epithelial-mesenchymal transition, directional migration, and cell-cell fusion. During gastrulation, they secrete a bilaterally symmetrical pair of skeletal primordia on the oral (ventral) aspect of the blastocoel wall, in close association with specialized ectodermal territories (Fig. 2A). The skeletal rudiments elongate and branch in a characteristic manner and, by the time the early larva begins to feed, a complex, branched network of skeletal rods supports its angular body (Fig. 2B,C).

At present, the micromere-PMC GRN consists of approximately 70 genes (a schematic view of the network is shown in Fig. 3). Recent studies have shed new light on the earliest events in the deployment of this GRN (Fig. 4). It was shown previously that activation of the network depends upon maternally derived components of the canonical Wnt signaling pathway, a pathway that plays a key role in early axis specification in diverse animal phyla (reviewed by Ettensohn, 2006).  $\beta$ -Catenin is an essential early activator of the micromere-PMC GRN and is likely to act exclusively and directly via activation of *pmar1* (*paired-class micromere anti-repressor 1*), which encodes a transcriptional repressor of the homeodomain family (Kitamura et al., 2002; Oliveri et al., 2002; Oliveri et al., 2003; Nishimura et al., 2004; Yamazaki et al., 2005). Although  $\beta$ -catenin protein is present throughout the vegetal region of the embryo during early cleavage, it activates *pmar1* only in the micromeres, by mechanisms that are not understood. Because Pmar1 functions as a transcriptional repressor, it was postulated that activation of the micromere-PMC GRN might be mediated by a double-repression mechanism (Oliveri et al., 2002). In support of this view, a recent screen for Pmar1-repressed genes identified *hesC* (*hairly/Enhancer-of-split C*), which encodes a transcriptional repressor (Revilla-i-Domingo et al., 2007). *HesC* mRNA is ubiquitous in the early embryo, but is downregulated in vegetal cells, including in the presumptive PMCs. Morpholino (MO)-mediated knockdown of *HesC* leads to excessive numbers of mesenchymal cells and to the upregulation of several early genes in the network. These findings indicate that a double-repression ‘gate’ mediated by *pmar1* and *hesC* activates the skeletogenic GRN. The fact that this GRN can be deployed throughout much of the embryo

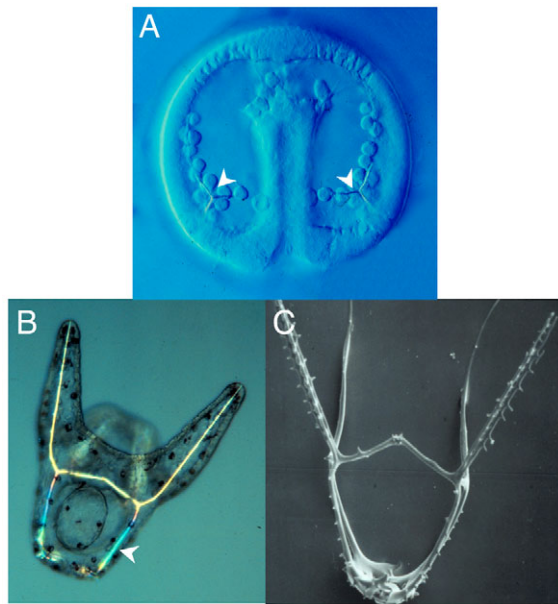
(for example, as a consequence of *pmar1* overexpression or *hesC* knockdown) indicates that any transcriptional activators required to initiate the network must be widely distributed.

In other recent work, Oliveri and co-workers (Oliveri et al., 2008) expanded the micromere-PMC GRN by carrying out MO-mediated knockdowns of many of the TFs that are expressed selectively in this lineage, including several that had not previously been analyzed. Quantitative polymerase chain reaction (QPCR) was used to assess the effects of such gene knockdowns on the expression of many of the regulatory (TF-encoding) genes in the network and on the expression of a smaller sampling of biomineralization-related genes. This work has highlighted the progressive, temporal elaboration of the GRN and the many feedback interactions that are associated with it, some of which are shown in Fig. 5. A small set of key, early regulatory genes, including *alx1* (*aristaleless-like homeobox 1*), *ets1* (*E26 transformation specific 1*) and *tbr* (*T-brain*), is activated in the large micromere progeny, through the *pmar1/hesC* double-repression system. These early TFs, in turn, activate a set of later regulatory genes, including *erg* (*ets-related gene*), *hex* (*hematopoietically expressed homeobox*), *tgif* (*TG-interacting factor*), and several others. Many of the regulatory genes in the network engage in mutual, positive interactions that probably stabilize the system (an example shown in Fig. 5 is the positive regulatory interaction between *tgif* and *hex*). The TFs encoded by these genes activate terminal differentiation genes (biomineralization genes), often via ‘feed-forward’ interactions in

#### Box 1. Comparative aspects of echinoderm skeletogenesis

The calcified endoskeleton is a distinctive feature of the echinoderm phylum and appeared during the early Cambrian period, at least 520 million years ago (Bottjer et al., 2006). Although the adult forms of all modern echinoderms produce a biomineralized skeleton, the embryos of different species vary considerably in this regard (note that most modern echinoderms exhibit maximal indirect development, the ancestral mode of development within the phylum, which is characterized by the development of feeding larvae that bear little resemblance to the corresponding adult forms). Of the five classes of modern echinoderms, only sea urchins and brittle stars form extensive embryonic skeletons, and only sea urchins produce micromeres. Starfish and sea cucumbers form little or no skeleton until late larval stages, when biomineral forms within the rudiment that will give rise to the adult body. Little information is available concerning the development of crinoids, which are considered to be basal within the echinoderms, but the available data indicate that crinoids also lack an embryonic skeleton (Nakano et al., 2003).

Sea urchin species typically used for developmental and genomic studies are members of subclass Euechinozoa. Relatively little attention has been paid to cidaroid urchins (subclass Perischoechinozoa), a group that includes only a handful of extant species. Cidaroid urchins are of interest because they are the basal group within the class, and all extant sea urchin species are believed to have radiated from a cidaroid-like ancestral stock that survived the Permian-Triassic extinction (Smith et al., 2006). In *Eucidaris tribuloides*, a representative cidaroid, variable numbers of micromeres form (Schroeder, 1981; Wray and McClay, 1988), and instead of forming an early-ingressing (primary) skeletogenic mesenchyme, its mesenchyme cells ingress late in gastrulation. A subset of these cells gives rise to skeletal elements, which arise late in gastrulation. A micromere lineage, an early-ingressing (primary) skeletogenic mesenchyme, and the embryonic skeletal structures it produces are therefore almost certainly recent inventions that appeared in a euechinoid ancestor about 250 million years ago.



**Fig. 2. Development of the embryonic skeleton of euechinoid sea urchins.** (A) A living sea urchin embryo (*Lytechinus variegatus*) at the late gastrula stage. The PMCs adopt a characteristic ring-like pattern within the blastocoel and secrete two skeletal rudiments (arrowheads). (B) A living pluteus larva (*L. variegatus*) viewed with partially crossed polarizers (image courtesy of Dr Rachel Fink, Mount Holyoke College). The mineralized skeleton (arrowhead) is birefringent. (C) Scanning electron micrograph of the late embryonic skeleton (*Dendraster excentricus*), with all cellular material removed.

which, for example, TF-A provides a positive input into gene *B*, and TF-A and the TF encoded by gene *B* both provide positive inputs into gene *C*. Several instances of such feed-forward interactions are illustrated in Fig. 5 [for example, the positive input from *ets1* (TF-A) to *alx1* (gene *B*) is accompanied by positive inputs from both transcription factors to *dri* (gene *C*)].

The terminal genes in the GRN, which encode proteins that mediate biomineralization, were recently surveyed in a genome-wide analysis (Livingston et al., 2006). Based on this and earlier work (reviewed by Wilt and Etensohn, 2007), approximately 30 biomineralization proteins have now been identified (Table 1). Fifteen of these proteins are spicule matrix proteins, a family of secreted proteins that are localized within the biomineral. Spicule matrix proteins have a characteristic structure that consists of a single C-lectin domain and often (but not always) a region of short repeats that are rich in proline, glycine, glutamine and/or asparagine residues (Illies et al., 2002). A small family of acidic, serine-rich, PMC-specific transmembrane proteins has also been identified, and the founding member (P16) has been shown to play an important role in skeletal rod elongation (Cheers and Etensohn, 2005). Other biomineralization-related proteins include several collagens and a PMC-specific carbonic anhydrase (Livingston et al., 2006). The identification of the complete repertoire of biomineralization-related genes has provided an unparalleled picture of the terminal output of this GRN. In addition, the identification of these genes has revealed features of their evolution and of the evolution of biomineralization mechanisms more generally (see Box 2).

The current micromere-PMC GRN is remarkable in its detail and serves as a model of GRN architecture. Nevertheless, even this impressive GRN remains incomplete, as many

biomineralization genes and several additional regulatory genes have yet to be connected to the network. Although MO-based knockdowns and QPCR analysis point to the existence of connections (direct or indirect) between genes, the validation of such connections requires the analysis of cis-regulatory elements of the relevant genes. The cis-regulatory architecture of several genes in the micromere-PMC network is understood in detail, mostly from heroic efforts in the laboratory of Eric Davidson (Makabe et al., 1995; Revilla-I-Domingo et al., 2004; Minokawa et al., 2005; Amore and Davidson, 2006; Ochiai et al., 2008), but most genes in the network have not been analyzed in this regard. Exhaustive cis-regulatory analysis of every gene in the network may not be feasible or informative, but additional studies of this kind are certainly warranted.

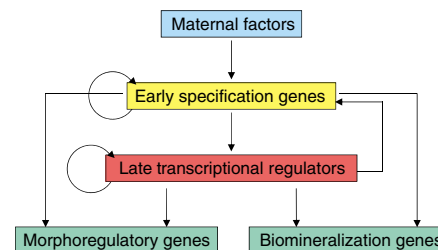
### Evolutionary insights from the skeletogenic GRN

The construction of detailed, developmental GRNs is important because these networks allow one to move beyond whether an individual gene, gene expression pattern or anatomical structure is shared between two organisms, and to consider the extent to which large blocks of genomic regulatory circuitry have been conserved. As a corollary, it is now possible to dissect in detail the changes in genomic regulatory mechanisms that have occurred during evolution, by carefully comparing the architecture of related GRNs in different species. The establishment of links between GRNs and the anatomy of organisms is also very important, because morphological variation within populations (a substrate for natural selection) may ultimately be interpretable in terms of the properties of GRNs.

### Evolutionary changes in skeletogenic GRN architecture

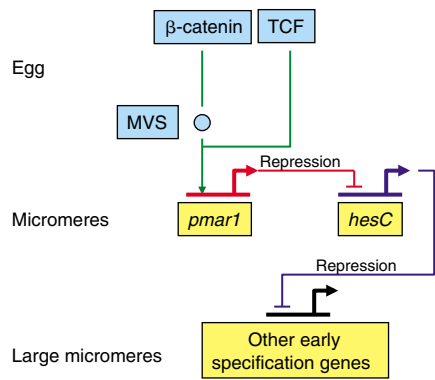
Comparative studies of skeletogenesis in various echinoderms support the view that two heterochronic shifts in the deployment of the skeletogenic GRN (that is, changes in the developmental timing of GRN deployment) occurred following the emergence of the sea urchin lineage. The first imported an ancestral, adult program of skeletogenesis into the late embryo. The second shifted this program even earlier in embryogenesis, and was associated with the invention of micromeres and an early-ingressing, skeletogenic mesenchyme (Fig. 6).

Against this evolutionary backdrop, recent studies have explored changes that have taken place in the architecture and deployment of the skeletogenic GRN during the last ~500 million years. It has been



**Fig. 3. Main layers of regulatory control within the PMC GRN.** The earliest inputs into the PMC GRN are from maternal factors (blue box), followed by those of early specification genes (yellow box), and late transcriptional regulators (red box). As a consequence of these regulatory functions, two classes of terminal differentiation genes (green boxes) are activated: one that controls morphogenetic behaviors of the PMCs (morphoregulatory genes) and one that governs the synthesis of the endoskeleton (biomineralization genes). Regulatory interactions within and between levels are indicated by arrows.

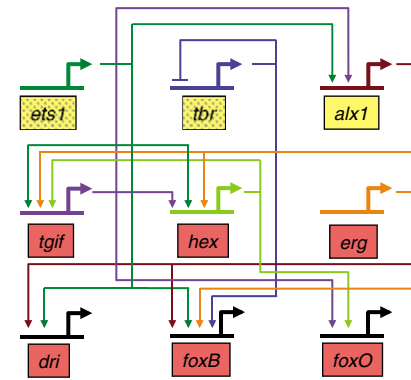




**Fig. 4. Activation of the PMC GRN.** Selected components of the maternal (blue) and early specification regulatory layers (yellow) are shown (see also Fig. 3).  $\beta$ -Catenin is stabilized in micromeres and in other vegetal blastomeres by a maternally controlled vegetal stabilization system (MVS), which requires the function of Dishevelled and other maternal Wnt signaling components.  $\beta$ -Catenin, acting with TCF, directly activates (green arrow) *pmar1* in the micromeres. Throughout most of the embryo, HesC represses (blue line) early PMC specification genes. This repression is relieved in the micromere territory, where Pmar1 blocks *hesC* expression (red line), either directly or indirectly. Note that additional mechanisms play a role in restricting *pmar1* expression to the micromeres, as  $\beta$ -catenin is stabilized throughout a broader vegetal domain. Similarly, although *hesC* is repressed throughout the micromere territory, unknown mechanisms restrict the activation of downstream PMC specification genes to the large micromere lineage.

known for some time that several biomineralization proteins are used in both the adult and the embryo of the sea urchin, pointing to similarities in these two programs of skeletogenesis (Wilt and Ettensohn, 2007). There are minor differences in the utilization of these genes in the embryo and adult, the functional significance of which is unclear. For example, the *sm30* (*spicule matrix protein, 30 kd*) gene family consists of six clustered paralogous genes, some of which are expressed selectively in either the adult or the embryonic skeletal tissue of sea urchins (Livingston et al., 2006).

Gao and co-workers (Gao and Davidson, 2008) have recently examined the expression of several upstream transcriptional regulators of the micromere-PMC GRN during early phases of adult skeletogenesis. In sea urchins and other echinoderms that exhibit indirect development (that is, that form feeding larvae that bear little resemblance to the corresponding adult forms) the adult body arises from a larval structure known as the echinus rudiment. During metamorphosis, most of the larval tissues die and the juvenile sea urchin emerges from the remnants of the larval body. Skeletogenesis begins within specific regions (skeletogenic centers) of the juvenile sea urchin while it is still growing within the feeding larva. Gao and co-workers used whole-mount in situ hybridization (WMISH) to show that several TFs used during embryonic skeletogenesis, including *ets1*, *alx1*, *erg*, *hex*, *tgif*, *jun* (*ju-nana*) and *dri* (*dead-ringer*), are also expressed selectively within the skeletogenic centers of the juvenile sea urchin. Other TFs of the embryonic GRN, however, including *tbr*, *tel* (*transforming-Ets-leukemia*), *foxB* (*forkhead box B*), *foxO* and *foxN2/3*, are absent from the skeletogenic centers of the juvenile, or are expressed at levels too low to be detected by WMISH. These findings suggest that the heterochronic shift in the deployment of the GRN into the embryo involved the importation



**Fig. 5. Selected regulatory interactions among early specification genes and late transcriptional regulators in the micromere-PMC GRN.** This schematic is based on the work of Oliveri et al. (Oliveri et al., 2008), although certain gene interactions have been omitted from their GRN, either for clarity or because the data supporting the links are equivocal. Yellow boxes indicate early specification genes and red boxes indicate late transcriptional regulators. Two of the early specification genes shown (*ets1* and *tbr*) are also expressed maternally (indicated by stippling). The interactions shown are based on morpholino knockdown studies and may be indirect. Arrows indicate positive interactions and bars indicate negative interactions.

of many regulatory components that were originally used for skeletogenesis in the adult. In addition, new regulatory connections appear to have been added, based on the finding that some TFs appear to be used only during the embryonic phase of skeletogenesis. One significant difference reported by Gao et al. was the absence of *pmar1* expression in juvenile skeletogenic centers. A potential caveat is that *pmar1* is expressed very transiently during PMC specification, and a brief period of expression in juvenile skeletogenic cells would probably have been difficult to detect. Nevertheless, the data suggest that the upstream regulation of the embryonic network, i.e. the double-repression system based on *pmar1* and *hesC*, was probably an evolutionary add-on. Other findings, discussed below, bolster the view that the invention of this system required the forging of a new link between two pre-existing programs: an ancestral (adult) biomineralization GRN and an even more ancient maternal patterning system based on the polarized degradation of  $\beta$ -catenin (Ettensohn et al., 2007).

Looking even deeper in evolutionary time, comparisons between the sea urchin GRN and the skeletogenic GRNs of other classes of echinoderms are now being drawn. Starfish are a distant relative of sea urchins within the Echinodermata. Gao et al. (Gao and Davidson, 2008) examined the expression of several TFs in the juvenile skeletogenic centers of starfish by WMISH and found evidence of the expression of *ets1*, *alx1*, *hex* and *dri*, which are therefore likely to be ancient regulatory components, but not of *foxB* or *tbr*. The lack of *tbr* expression in the juvenile skeletogenic centers of both sea urchins and starfish strongly suggests that the recruitment of this gene into the large micromere-PMC GRN occurred relatively recently. Indeed, Hinman et al. (Hinman et al., 2007) have found that in starfish, *tbr* is expressed throughout the endomesoderm in a pattern very different from that observed in sea urchins. *tbr* orthologs are broadly expressed throughout the endomesoderm in several vertebrates and in other invertebrate deuterostomes, suggesting that this is the ancestral pattern. In

**Table 1. Biomineralization genes in the sea urchin**

Gene	Protein	Expression in embryo	Reference
<i>sm30A</i>	Spicule matrix protein	PMCs	Livingston et al., 2006
<i>sm30B</i>	Spicule matrix protein	PMCs	George et al., 1991
<i>sm30C</i>	Spicule matrix protein	PMCs	Akasaka et al., 1994
<i>sm30D</i>	Spicule matrix protein	Low* (but high in adult skeleton)	Livingston et al., 2006
<i>sm30E</i>	Spicule matrix protein	PMCs	Livingston et al., 2006
<i>sm30F</i>	Spicule matrix protein	Low* (but high in adult skeleton)	Livingston et al., 2006
<i>sm29</i>	Spicule matrix protein	PMCs	Illies et al., 2002
<i>pm27</i>	Spicule matrix protein	PMCs	Harkey et al., 1995
<i>sm37</i>	Spicule matrix protein	PMCs	Lee et al., 1999
<i>sm32/50</i>	Spicule matrix protein	PMCs	Benson et al., 1987; Livingston et al., 2006
<i>Clectin</i>	Spicule matrix protein	PMCs	Illies et al., 2002
<i>spu_005989</i>	Spicule matrix protein	Low*	Livingston et al., 2006
<i>spu_005991</i>	Spicule matrix protein	Low*	Livingston et al., 2006
<i>spu_005992</i>	Spicule matrix protein	High*	Livingston et al., 2006
<i>spu_027906</i>	Spicule matrix protein	PMCs	Livingston et al., 2006
<i>msp130</i>	Novel cell surface protein	PMCs	Leaf et al., 1987
<i>msp130rel1</i>	Novel cell surface protein	PMCs	Illies et al., 2002
<i>msp130rel2</i>	Novel cell surface protein	PMCs	Illies et al., 2002
<i>msp130rel3</i>	Novel cell surface protein	PMCs	Livingston et al., 2006
<i>msp130rel4</i>	Novel cell surface protein	Low*	Livingston et al., 2006
<i>msp130rel5</i>	Novel cell surface protein	PMCs	Livingston et al., 2006
<i>msp130rel6</i>	Novel cell surface proteins	Low*	Livingston et al., 2006
<i>cyp1</i>	Peptidylprolyl cis-trans isomerase	PMCs	Amore and Davidson, 2006
<i>cyp2 (spu_007944)</i>	Peptidylprolyl cis-trans isomerase	PMCs	Livingston et al., 2006
<i>colp3<math>\alpha</math></i>	Collagen (non-fibrillar)	PMCs	Angerer et al., 1988; Livingston et al., 2006
<i>colp4<math>\alpha</math></i>	Collagen (non-fibrillar)	PMCs	Exposito et al., 1994
<i>can1 (spu_012518)</i>	Carbonic anhydrase (secreted)	PMCs (and adult skeleton)	Livingston et al., 2006
<i>p16</i>	Novel transmembrane protein	PMCs	Illies et al., 2002
<i>spu_018403</i>	Novel transmembrane protein	PMCs	Livingston et al., 2006
<i>spu_018407</i>	Novel transmembrane protein	PMCs	Livingston et al., 2006
<i>p19</i>	Novel cytoplasmic protein	PMCs	Illies et al., 2002

\*The distribution of the mRNA in embryonic tissues is not known.  
PMC, primary mesenchyme cell.

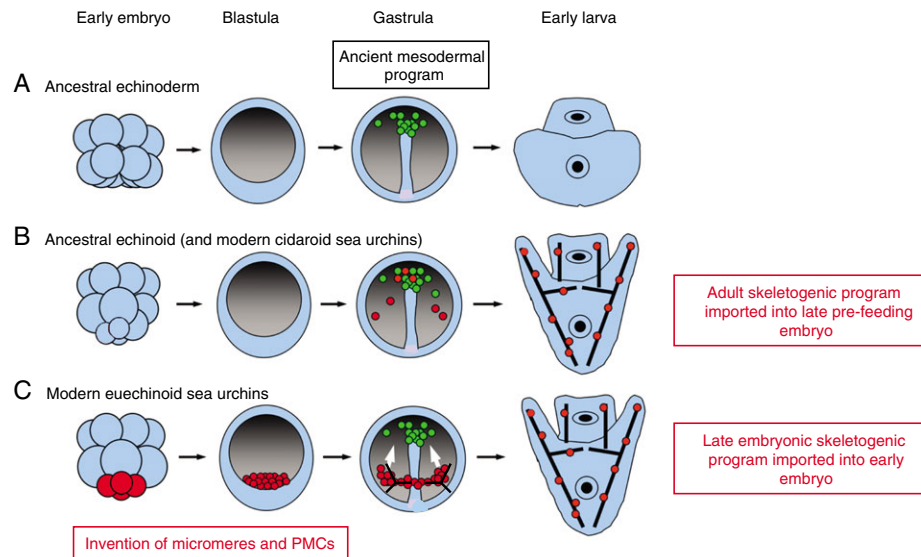
starfish, *tbr* regulates several genes involved in specification of the endomesoderm, including *delta*, *otx* (*orthodenticle homeobox*), *gatae* (*GATA-binding transcription factor E*), *foxa* and *bra* (*brachyury*) (Hinman and Davidson, 2007; Hinman et al., 2007). Hinman and co-workers (Hinman et al., 2007) have shown that, in the case of *otx*, this regulatory interaction is direct, and propose that in sea urchins the link between these two genes has been replaced by other changes in GRN architecture, thereby allowing *tbr* to change its developmental role.

### The invention of a new cell lineage

The evolutionary invention of the *pmar1/hesC* double-repression system paralleled the invention of micromeres. In euechinoid sea urchins, the mitotic spindle of each of the four vegetal blastomeres of the eight-cell-stage embryo interacts with the vegetal cortex and becomes positioned near to the vegetal pole, which results in an unequal cell division. A similar process occurs at the fifth cleavage division, when each micromere divides unequally to produce large and small daughter cells. These unequal cell divisions appear to be necessary for PMC specification, as chemical treatments that equalize the divisions also block PMC formation (Langelan and Whiteley, 1985). These observations suggest that: (1) the molecular events that activate the PMC GRN in the large micromeres are functionally linked to unequal (asymmetric) cell division, by a molecular mechanism that is presently unknown; and (2) the cell biological mechanisms that produce unequal divisions evolved in parallel with the appearance of the new regulatory linkages in the GRN. Cidaroid sea urchins may represent a transitional state in this respect, as they form variable numbers of micromeres during

### Box 2. The evolution of biomineralization proteins

Biomineralization is regulated by secreted proteins that control the growth and physical properties of the material (Baeuerlein, 2007). In sea urchins, the genes that encode these proteins are members of small gene families and are tightly clustered in the genome, which suggests that they expanded relatively recently by duplication (Livingston et al., 2006). The situation in vertebrates is similar in many respects; genes encoding secreted proteins that are associated with tooth and bone (SCPP proteins) are clustered in the genome and arose by a series of duplications (Kawasaki and Weiss, 2006). As in sea urchins, many of these secreted proteins are rich in proline and glutamine (a composition typically associated with relatively unordered protein structure), whereas others are unusually acidic and rich in phosphoserines. The fossil record indicates that biomineralized tissues arose separately in the vertebrates and echinoderms after their divergence; therefore, vertebrate and echinoderm skeletons are not homologous in the strictest sense. Moreover, SCPP proteins in vertebrates are believed to have arisen from an ancestral SPARC ('secreted protein acidic cysteine-rich') gene, whereas this does not appear to be the case with respect to the secreted biomineralization proteins in echinoderms, many of which probably arose from an ancestral C-lectin domain-containing protein (Livingston et al., 2006). Both groups of organisms appear to employ similar kinds of proteins for controlling biomineralization, however, suggesting either that they independently co-opted proteins with similar biochemical properties or that they converged by other mechanisms on similar biochemical strategies for biomineralization. In both the vertebrate and echinoderm lineages, the genes encoding secreted biomineralization proteins expanded by duplication and subsequently diverged relatively rapidly.



**Fig. 6. Evolutionary modifications in echinoderm skeletogenesis.** Only embryonic and larval stages are illustrated. Green cells indicate non-skeletogenic mesoderm, red cells indicate skeletogenic mesoderm, and heavy black lines represent skeletal rods. **(A)** The ancestral echinoderm exhibited indirect development and had an adult skeleton. The embryo had an ancestral program of mesoderm specification but lacked a skeleton. **(B)** In the ancestral echinoid, the adult program of biomineralization was imported into the late embryo. This pattern of skeletogenesis is still seen in modern cidaroid sea urchins. **(C)** In modern euechinoids, a second heterochronic change occurred, shifting the skeletogenic program into the early embryo. This change was associated with the invention of micromeres and an early-ingressing, skeletogenic mesenchyme (PMCs). It required the establishment of new regulatory links between the ancestral skeletogenic GRN and an even more ancient system of early patterning mediated by  $\beta$ -catenin. It was also associated with the invention of a PMC-derived signal that suppresses the skeletogenic potential of NSM cells (white arrows).

cleavage and lack an early skeletogenic mesenchyme (Box 1). One very unusual feature of the *pmar1* gene may be related to its relatively recent recruitment into the PMC GRN; in all three species of euechinoid urchins that have been examined, the *pmar1* locus consists of several (at least ten) nearly identical, tandem copies of the gene (Nishimura et al., 2004; Etensohn et al., 2007; Sea Urchin Genome Sequencing Consortium, 2006). This suggests that recent duplications of the *pmar1* gene might have been associated with its shift in developmental function.

### The skeletogenic GRN and developmental plasticity

GRNs are a powerful tool with which to address the long-standing problem of developmental plasticity. Early experimental embryological manipulations of sea urchin embryos were the first to lead to an appreciation of regulative development (Driesch, 1892; Hörstadius, 1939). The plasticity of sea urchin development seems at odds, however, with clear evidence that: (1) the fates of blastomeres are biased at early stages; (2) embryonic patterning is entrained by molecular asymmetries within the unfertilized egg; and (3) distinct domains of differential gene expression arise very early in development. Despite early patterning processes, cell specification in early sea urchin embryos remains strikingly labile. This feature of early embryogenesis is not unique to echinoderms. Recent studies of early mammalian development also suggest that early developmental biases and regulative properties may co-exist (Zernicka-Goetz, 2006). The inescapable conclusion from work with the sea urchin is that early developmental GRNs are conditionally deployed and subject to extensive modifications by extrinsic signals. One hypothesis is that GRNs become less labile after feedback interactions are established among regulatory genes in the network, a state that may render networks relatively refractory to reprogramming.

### Ectopic deployment of the skeletogenic GRN

Some of the most striking examples of plasticity in sea urchin development involve ectopic deployment of the skeletogenic GRN in non-micromere-derived cells. Indeed, a remarkable feature of sea urchin development is that every blastomere of the early embryo can express a skeletogenic fate. A variety of surgical and molecular manipulations have revealed this developmental plasticity (Fig. 7).

Some populations of cells retain the capacity to activate the micromere-PMC GRN even after the onset of gastrulation. Microsurgical removal of PMCs at the early-gastrula stage triggers a conversion of non-skeletogenic mesoderm (NSM) cells to the PMC fate. Transfating is followed by the synthesis of a complete, well-patterned skeleton, albeit in a delayed fashion (reviewed by Etensohn, 1992). Recent analysis has shown that NSM transfating is associated with the activation of many (probably all) of the downstream biomineralization genes in the micromere-PMC GRN (Etensohn et al., 2007). Significantly, several of the regulatory genes of the skeletogenic GRN are normally expressed both by PMCs and NSM cells, including *ets1*, *erg*, *tel*, *hex*, *snail*, *foxN2/3* and *foxO*, which suggests that there are many similarities in the genomic regulatory states of these two cell types (Fig. 8A). One critical, early transcriptional regulator that is normally absent from NSM cells, however, is the homeodomain protein *Alx1* (Etensohn et al., 2003). *alx1* expression is activated early in the transfating response (Fig. 8B-D) and this activation is essential for a complex suite of downstream, PMC-specific behaviors. In the micromere-PMC lineage, *alx1* is regulated by the maternal  $\beta$ -catenin-based patterning system through *pmar1*, which is likely to be a direct target of  $\beta$ -catenin. During transfating, however, *alx1* is activated by novel, *pmar1*-independent inputs (Etensohn et al., 2007). Consistent with the pivotal role of *alx1* in re-programming NSM cells, ectopic expression of this protein is sufficient to cause NSM cells to express a PMC fate, and to trigger

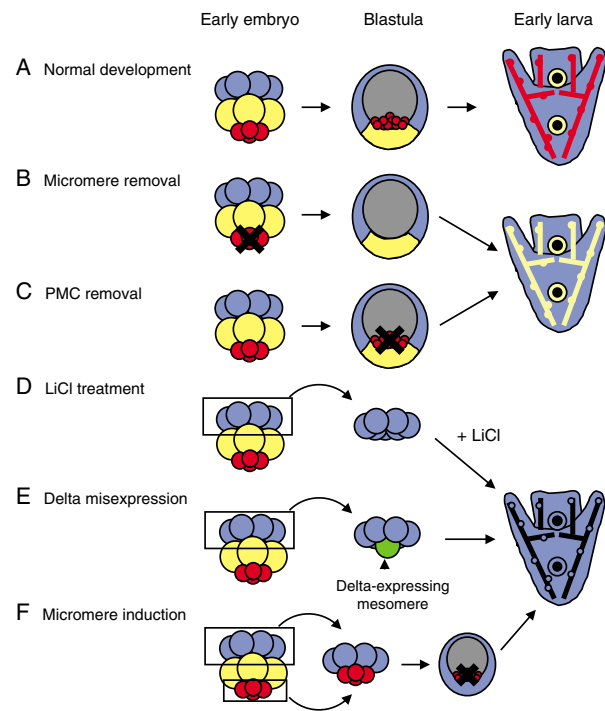
morphogenetic behaviors that are characteristic of PMCs, as well as the activation of downstream biomineralization genes (Fig. 8E). NSM transfecting therefore exemplifies a situation in which many components of a particular GRN are already deployed as part of an initial regulatory state. A key subcircuit is missing, however: one that provides essential inputs into cell-specific morphoregulatory genes and the cell behaviors they control.

The transfecting of NSM cells is illuminating in another respect, as it reveals a situation in which developmental plasticity is coupled to the evolutionary progression of a developmental program. One intriguing hypothesis is that NSM transfecting recapitulates an ancestral program of skeletogenesis. As described in Box 1, micromeres and a precocious (early-ingressing) skeletogenic mesenchyme are novelties of euechinoid development. If the development of modern cidaroids is accepted as a proxy for the ancestral echinoid program, then a skeletogenic mesenchyme that formed relatively late in development, and which was specified by mechanisms that were independent of micromere formation and the *pmar1/hesC* system, was the primordial state. These are characteristics of NSM transfecting (Ettensohn et al., 2007). The invention of an early-ingressing skeletogenic mesenchyme may have been accompanied by the creation of new cellular interactions that suppressed the skeletogenic potential of the ancestral population, by inactivating a key, *Alx1*-mediated subcircuit of the skeletogenic GRN. According to this view, the plasticity of NSM cells is a manifestation of a primordial developmental function (and a primordial genomic regulatory state), which has been overlaid by more recent modifications. A prediction of this model is that regulatory inputs into the *alx1* gene in cidaroids will prove to be similar to those in transfecting, skeletogenic NSM cells of euechinoids, and will be similarly independent of the *pmar1/hesC* double-repression system that operates in micromeres.

NSM cells are not the only cells in the gastrula-stage embryo that can express a skeletogenic fate, and in some cases it appears that the change in genomic regulatory state is more extensive than is observed during NSM transfecting. The surgical removal of both PMCs and NSM cells during gastrulation leads to the transfecting of endoderm cells to a PMC fate (McClay and Logan, 1996). The regulatory state of endoderm cells at the gastrula stage is clearly very different from that of NSM cells, and it will be instructive to investigate the changes in GRN architecture that accompany this particular re-specification process. Even more extensive re-wiring of GRNs is likely to underlie skeletogenesis during the remarkable process of larval cloning; i.e., the budding of complete, new individuals from small regions of advanced larvae (Eaves and Palmer, 2003; Vaughn and Strathmann, 2008).

### Competition between GRNs

The specification of embryonic cells can be viewed as a competition between GRNs. The most dominant networks may be those with the most robust positive-feedback interactions or the greatest ability to repress other genetic programs (Niwa, 2007). At the heart of genomic reprogramming is the ability of one transcriptional GRN to dominate another. In the sea urchin, there are several examples of such dominance at work. The best understood of these are associated with the repression of the GRN that governs the specification of pigment cells, a major sub-population of cells within the NSM. The NSM arises at the blastula stage from a torus-shaped region located between the prospective PMCs and the prospective endoderm. The initial specification of pigment cells within this territory is dependent upon a local Delta signal presented by adjacent prospective PMCs (Sherwood and McClay, 1999; Sweet et al., 2002). This signal acts

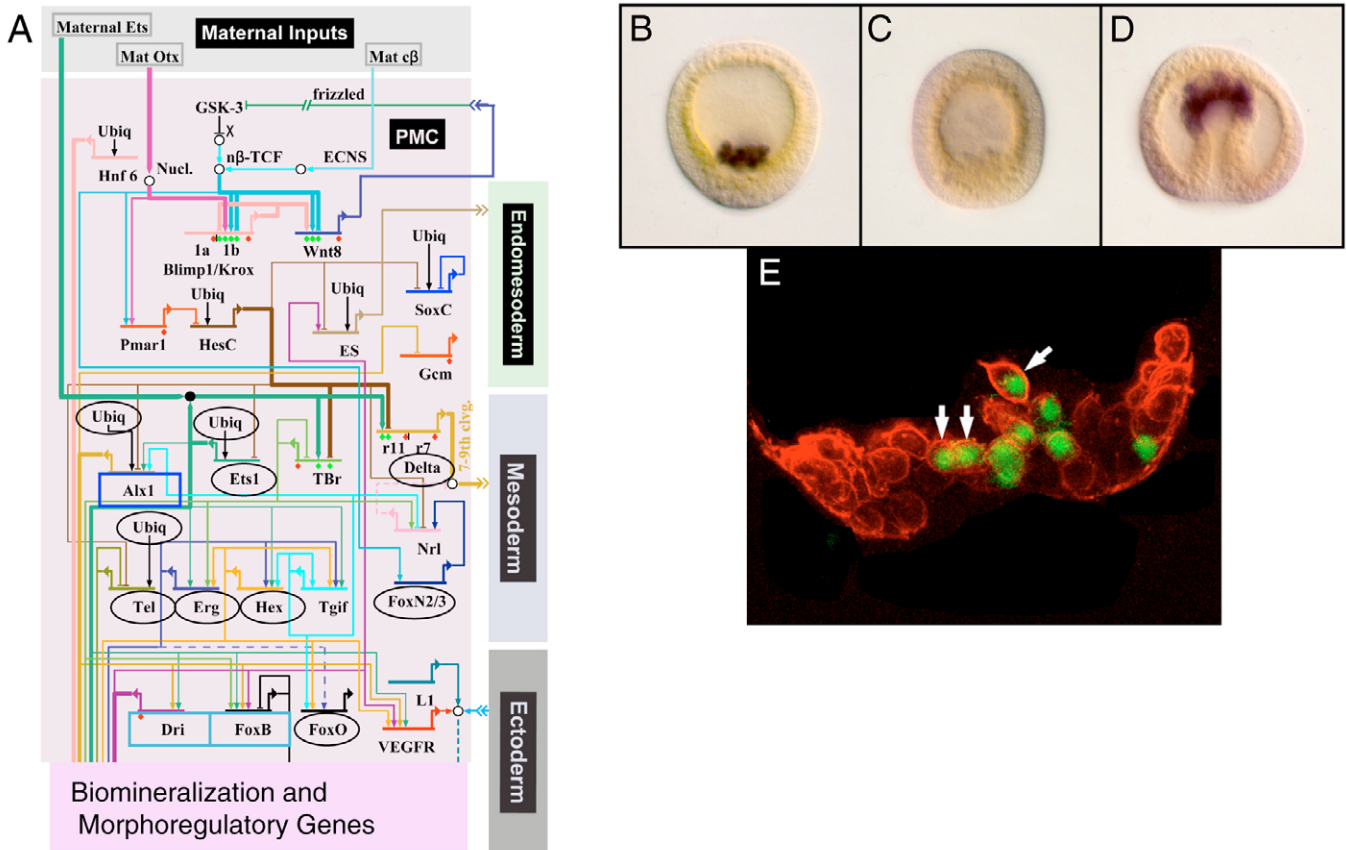


**Fig. 7. Alternative deployment of the micromere-PMC GRN.** (A) In undisturbed embryos, only micromeres (red cells in the early embryo), or more precisely, their large daughter cells, give rise to PMCs (red cells at the blastula stage) and the embryonic skeleton (red rods in the early larva). (B,C) Removal of micromeres or PMCs leads to deployment of the skeletogenic GRN by NSM cells, which are derived from macromeres (yellow) (Hörstadius, 1939; Ettensohn, 1992). (D-F) Animal cells, derived from mesomeres (blue), can be induced to activate the skeletogenic GRN by LiCl treatment (Livingston and Wilt, 1989), by the mis-expression of Delta (Sweet et al., 2002) or of *Pmar1* (Oliveri et al., 2002), or by inductive signals from micromeres (Minokawa et al., 1997).

through the ubiquitous Notch receptor and impinges directly on the key regulatory gene *gcm* (*glial cells missing*) via Su(H) (Suppressor of Hairless) target sites in the cis-regulatory apparatus of this gene (Ransick and Davidson, 2006). *gcm*, in turn, provides essential inputs into several terminal differentiation genes that regulate pigment biosynthesis (Calestani et al., 2003).

In the large micromere progeny, *Alx1* is required not only to activate a key subcircuit within the skeletogenic GRN, but also to repress *gcm* and downstream differentiation genes of the pigment cell GRN. In the absence of *Alx1*, the pigment cell GRN is activated in at least some of these cells as a consequence of the Delta signal, which is produced by large micromere progeny in an *alx1*-independent manner (Ettensohn et al., 2003; Ettensohn et al., 2007; Oliveri et al., 2008). The mechanism by which *Alx1* represses *gcm* is not known, but the dual role of this TF in activating one circuit while simultaneously repressing another is instructive. The *foxa* gene plays a rather analogous role in the prospective endoderm, where this gene represses *gcm* and prevents prospective endoderm cells from deploying the pigment cell GRN (Oliveri et al., 2006). *foxa* also has positive regulatory inputs into endodermal genes, but at later stages of development. The term ‘exclusion effect’ has been used to describe the linking of a particular GRN network to transcriptional repressors that target regulatory genes required for





**Fig. 8. Alternative deployment of the micromere-PMC GRN by NSM cells.** (A) An expanded view of the PMC GRN [modified, with permission, from Oliveri et al. (Oliveri et al., 2008)]. Many regulatory components of the micromere-PMC GRN are normally deployed in NSM cells (black ovals). One key regulator not expressed by these cells is *alx1* (dark blue box). *alx1* controls a subcircuit that activates biomineralization and morphoregulatory genes via intermediaries such as *dri*, *foxB* (light blue boxes) and *snail* (not shown). (B–D) Ectopic deployment of *alx1* during NSM transfecting (*L. variegatus*). (B) An embryo at the mesenchyme blastula stage. *alx1* mRNA expression (dark purple) is restricted to PMCs. (C) A mesenchyme blastula stage embryo immediately after the microsurgical removal of PMCs. (D) An embryo 6 hours after the microsurgical removal of PMCs. *alx1* is expressed ectopically (dark purple) by NSM cells at the tip of the archenteron. Activation of *alx1* in NSM cells occurs by a novel, *pmar1*-independent mechanism. (E) Expression of *alx1* is sufficient to trigger NSM transfecting. Co-injection of *alx1* mRNA and a lineage tracer (green nuclear label) into one macromere at the 16-cell stage induces descendants of the labeled cell to adopt the PMC fate, as shown by immunostaining using a monoclonal antibody that recognizes MSP130 proteins, a family of PMC-specific cell surface proteins (red). White arrows mark transfected cells. Figure modified, with permission, from Ettensohn et al. (Ettensohn et al., 2007).

alternative regulatory states (Oliveri and Davidson, 2007). Perhaps no issue will be more important for understanding developmental plasticity than elucidating the specific regulatory connections between GRNs that cause one network to be repressed when another is deployed.

### Linking the skeletogenic GRN to morphogenesis

Another current challenge is to link early GRNs with the specific morphogenetic processes that underlie changes in form. Although the immediate biochemical events that drive changes in cell behavior are likely to be regulated primarily by post-translational mechanisms, it is nevertheless appropriate to view the overall morphogenetic state of a cell as an output of the transcriptional GRNs that operated earlier in the history of that cell lineage. A prerequisite for establishing connections between GRNs and morphogenesis is a thorough understanding of the mechanical basis of specific morphogenetic events at the cellular/tissue level, and knowledge of the specific effector proteins (such as adhesion proteins, cytoskeletal proteins, their regulators, and the like) that mediate such events.

The formation of the endoskeletal system of euechinoid sea urchins is likely to be the first morphogenetic process to be understood in such a way. The skeleton determines the angular shape of the sea urchin larva and influences its swimming and orientation (see Wilt and Ettensohn, 2007). Skeletogenesis is very well understood at the cellular level, and recent studies have shed further light on the molecules that regulate the distinctive morphogenetic behaviors of the PMCs. The first step in PMC morphogenesis, the ingression of the cells into the blastocoel via an epithelial-mesenchymal transition, is associated with the downregulation of cadherin at both transcriptional and post-translational levels. In the green sea urchin *Lytechinus variegatus*, both processes appear to be mediated by *snail*, which functions downstream of *alx1* in the micromere-PMC GRN (Wu and McClay, 2007).

Considerable evidence has shown that signals from overlying ectoderm cells play an important role in PMC migration and in the regulation of biomineralization-related genes. Recently, the molecular mechanisms of this interaction were clarified when it was shown that the directional migration of PMCs is dependent



on VEGF (vascular endothelial growth factor) and FGF (fibroblast growth factor) signaling (Duloquin et al., 2007; Rottinger et al., 2008). VEGF and FGF ligands are expressed in localized regions of the ectoderm that serve as PMC target sites, and the cognate receptor tyrosine kinases (*vegfr10* and *fgfr2*) are restricted to PMCs. MO knockdowns and mRNA misexpression experiments that disrupt either FGF or VEGF signaling result in aberrant PMC migration and skeletal patterning, and indicate that these pathways play non-redundant roles. Several potential regulatory inputs into the sea urchin *vegfr* gene have been identified (Oliveri et al., 2008).

Another inroad into an integrated, genomic regulatory view of skeletal morphogenesis has come from the analysis of the biomineralization proteins described above. At least two of these are required for skeletal rod growth, the spicule matrix protein SM50 (Peled-Kamar et al., 2002) and the novel transmembrane protein P16 (Cheers and Etensohn, 2005). *p16* is positively regulated by *alx1*, but other potential inputs have not yet been examined. The cis-regulatory architecture of *sm50* has been analyzed in considerable detail (Makabe et al., 1995) and several regulatory inputs into this gene have been identified (Oliveri et al., 2008), although the precise nature of the spatial control of this gene remains incompletely understood.

Clearly these studies are only a beginning. Much remains to be learnt at the cell biological level about the mechanisms of FGF- and VEGF-mediated PMC guidance, and a detailed dissection of the cis-regulatory control of the genes that encode the receptors within the PMC GRN has yet to be carried out. With respect to the biomineralization proteins, important questions remain that concern their biochemical properties, their potential functional redundancy, and the coordinated transcriptional regulation of the cognate genes. Other proteins that play key roles in PMC morphogenesis – for example, proteins that mediate cell-cell fusion – have yet to be identified. Despite these gaps in our understanding, the recent findings are tantalizing because they point the way to an elucidation of the genomic regulatory control of a major morphogenetic process in the embryo. They establish a continuous, if slender, conceptual thread that links the earliest polarity of the egg to the activation and progressive elaboration of a zygotic GRN, which, in turn, controls a complex anatomical feature.

## Conclusions

The work discussed here points towards a future that will be exciting and extraordinarily informative. Further efforts will be required to expand and refine GRNs that have already been constructed, and to elucidate networks that operate in other embryonic cell types. All of the essential experimental tools are in place for such analyses, although the detailed dissection of the cis-regulatory elements of genes remains a time-consuming bottleneck. As the body of information increases, it might become necessary to create new kinds of pictorial representations of GRNs that allow researchers to visualize and analyze these complex, dynamic networks.

It seems likely that comparative GRN analysis will emerge as a major enterprise of evolutionary developmental biology. Echinoderms will continue to be valuable experimental material for such studies, building on GRNs that are being constructed in the sea urchin. The phylum has an extensive fossil record and a robust phylogeny. Moreover, the embryos of many species are readily available (Foltz et al., 2004) and comparisons can be drawn over a wide range of evolutionary distances. Starfish have emerged as the vanguard for this kind of work, but other classes of echinoderms will follow. The development of new genomic resources for echinoderms

other than euechinoid sea urchins will be pivotal in this research. Fortunately, such information is likely to become available in the near future with the emergence of new and more affordable DNA-sequencing platforms.

Long-standing questions concerning the plasticity and regulative properties of embryos can now be reformulated in the new context of developmental GRNs. The rich history of experimental embryology has uncovered many examples of cellular reprogramming that can now be analyzed in terms of GRN re-wiring. In the sea urchin, recent studies of NSM transfecting have revealed that an intimate relationship exists between plasticity and the evolutionary progression of a developmental program. It seems reasonable to suggest that other examples of developmental plasticity will be better understood when placed in an evolutionary context.

An overarching goal will be to develop an integrated view of the genomic control of anatomy. The assembly and patterning of the euechinoid endoskeleton is likely to be the first morphogenetic process fully understood in genomic regulatory terms, but others will surely follow. In the sea urchin, the invagination and elongation of the archenteron may be the second, as new molecular players emerge (Beane et al., 2006; Croce et al., 2006) and as GRNs continue to be developed for various territories of the endomesoderm (Davidson et al., 2002). Work with other experimental models is also pointing in this direction, as efforts are underway to elucidate the genomic control of notochord morphogenesis in ascidians (Davidson and Christiaen, 2006; Munro et al., 2006; Satou et al., 2008), ventral furrow formation in *Drosophila* (Gong et al., 2004; Stathopolous and Levine, 2005; Sandmann et al., 2007), and vertebrate neural crest morphogenesis (Sauka-Spengler and Bronner-Fraser, 2008). An understanding of how the anatomy of the embryo is hard-wired in the genome, certainly one of the central problems in all of developmental and evolutionary biology, now seems accessible.

The author is grateful to V. Hinman and to three anonymous reviewers for their valuable suggestions. Research by the author that was discussed in this review was supported by the National Science Foundation.

## References

- Akasaka, K., Frudakis, T. N., Killian, C., George, N. C., Yamasu, K., Khaner, O. and Wilt, F. H. (1994). Genomic organization of a gene encoding the spicule matrix protein SM30 in the sea urchin *Strongylocentrotus purpuratus*. *J. Biol. Chem.* **269**, 20592-20598.
- Amore, G. and Davidson, E. H. (2006). Cis-Regulatory control of cyclophilin, a member of the ETS-DRI skeletogenic gene battery in the sea urchin embryo. *Dev. Biol.* **293**, 555-564.
- Angerer, L. M. and Angerer, R. C. (2003). Patterning the sea urchin embryo: gene regulatory networks, signaling pathways, and cellular interactions. *Curr. Top. Dev. Biol.* **53**, 159-198.
- Angerer, L. M., Chambers, S. A., Yang, Q., Venkatesan, M., Angerer, R. C. and Simpson, R. T. (1988). Expression of a collagen gene in the mesenchyme lineages of the *Strongylocentrotus purpuratus* embryo. *Genes Dev.* **2**, 239-246.
- Bauelein, E. (2007). *Handbook of Biomineralization*. Weinheim: Wiley-VCH.
- Beane, W. S., Gross, J. M. and McClay, D. R. (2006). RhoA regulates initiation of invagination, but not convergent extension, during sea urchin gastrulation. *Dev. Biol.* **292**, 213-225.
- Ben-Tabou de-Leon, S. and Davidson, E. H. (2007). Gene regulation: gene control network in development. *Annu. Rev. Biophys. Biomol. Struct.* **36**, 191.
- Benson, S., Sucov, H., Stephens, L., Davidson, E. and Wilt, F. (1987). A lineage-specific gene encoding a major spicule matrix protein of the sea urchin embryo spicule. I. Authentication of the cloned gene and its developmental expression. *Dev. Biol.* **120**, 499-506.
- Bottjer, D. J., Davidson, E. H., Peterson, K. J. and Cameron, R. A. (2006). Paleogenomics of echinoderms. *Science* **314**, 956-960.
- Brandhorst, B. P. and Klein, W. H. (2002). Molecular patterning along the sea urchin animal-vegetal axis. *Int. Rev. Cytol.* **213**, 183-232.
- Calestani, C., Rast, J. P. and Davidson, E. H. (2003). Isolation of pigment cell specific genes in the sea urchin embryo by differential macroarray screening. *Development* **130**, 4587-4596.

- Cheers, M. S. and Etensohn, C. A.** (2005). P16 is an essential regulator of skeletogenesis in the sea urchin embryo. *Dev. Biol.* **283**, 384-396.
- Croce, J., Duloquin, L., Lhomond, G., McClay, D. R. and Gache, C.** (2006). Frizzled5/8 is required in secondary mesenchyme cells to initiate archenteron invagination during sea urchin development. *Development* **133**, 547-557.
- Davidson, B. and Christiaen, L.** (2006). Linking chordate gene networks to cellular behavior in ascidians. *Cell* **124**, 247-250.
- Davidson, E. H.** (2006). *The Regulatory Genome: Gene Regulatory Networks in Development and Evolution*. San Diego, CA: Academic Press.
- Davidson, E. H., Rast, J. P., Oliveri, P., Ransick, A., Calestani, C., Yuh, C. H., Minokawa, T., Amore, G., Hinman, V., Arenas-Mena, C. et al.** (2002). A provisional regulatory gene network for specification of endomesoderm in the sea urchin embryo. *Dev. Biol.* **246**, 162-190.
- Driesch, H.** (1892). The potency of the first two cleavage cells in echinoderm development: experimental production of partial and double formations. In *Foundations of Experimental Embryology* (ed. B. H. Willier and J. M. Oppenheimer), pp. 38-55. 1974. New York: Hafner.
- Duloquin, L., Lhomond, G. and Gache, C.** (2007). Localized VEGF signaling from ectoderm to mesenchyme cells controls morphogenesis of the sea urchin embryo skeleton. *Development* **134**, 2293-2302.
- Eaves, A. A. and Palmer, A. R.** (2003). Reproduction: widespread cloning in echinoderm larvae. *Nature* **425**, 146.
- Etensohn, C. A.** (1992). Cell interactions and mesodermal cell fates in the sea urchin embryo. *Development* **116 Suppl.**, 43-51.
- Etensohn, C. A.** (2006). The emergence of pattern in embryogenesis: regulation of beta-catenin localization during early sea urchin development. *Sci STKE* **361**, pe48.
- Etensohn, C. A., Illies, M. R., Oliveri, P. and De Jong, D. L.** (2003). Alx1, a member of the Cart1/Alx3/Alx4 subfamily of Paired-class homeodomain proteins, is an essential component of the gene network controlling skeletogenic fate specification in the sea urchin embryo. *Development* **130**, 2917-2928.
- Etensohn, C. A., Kitazawa, C., Cheers, M. S., Leonard, J. D. and Sharma, T.** (2007). Gene regulatory networks and developmental plasticity in the early sea urchin embryo: alternative deployment of the skeletogenic gene regulatory network. *Development* **134**, 3077-3087.
- Exposito, J. Y., Suzuki, H., Geourjon, C., Garrone, R., Solorsh, M. and Ramirez, F.** (1994). Identification of a cell lineage-specific gene coding for a sea urchin alpha 2(IV)-like collagen chain. *J. Biol. Chem.* **269**, 13167-13171.
- Foltz, K. R., Adams, N. L. and Runft, L. L.** (2004). Echinoderm eggs and embryos: procurement and culture. *Methods Cell Biol.* **74**, 39-74.
- Gao, F. and Davidson, E. H.** (2008). Transfer of a large gene regulatory apparatus to a new developmental address in echinoid evolution. *Proc. Natl. Acad. Sci. USA* **105**, 6091-6096.
- Ge, H., Player, C. M. and Zou, L.** (2006). Toward a global picture of development: lessons from genome-scale analysis in *Caenorhabditis elegans* embryonic development. *Dev. Dyn.* **235**, 2009-2017.
- George, N. C., Killian, C. E. and Wilt, F. H.** (1991). Characterization and expression of a gene encoding a 30.6-kDa *Strongylocentrotus purpuratus* spicule matrix protein. *Dev. Biol.* **147**, 334-342.
- Gong, L., Puri, M., Unlü, M., Young, M., Robertson, K., Viswanathan, S., Krishnaswamy, A., Dowd, S. R. and Minden, J. S.** (2004). Drosophila ventral furrow morphogenesis: a proteomic analysis. *Development* **131**, 643-656.
- Harkey, M. A., Klueg, K., Sheppard, P. and Raff, R. A.** (1995). Structure, expression, and extracellular targeting of PM27, a skeletal protein associated specifically with growth of the sea urchin larval spicule. *Dev. Biol.* **168**, 549-566.
- Hinman, V. F. and Davidson, E. H.** (2007). Evolutionary plasticity of developmental gene regulatory network architecture. *Proc. Natl. Acad. Sci. USA* **104**, 19404-19409.
- Hinman, V. F., Nguyen, A. and Davidson, E. H.** (2007). Caught in the evolutionary act: precise cis-regulatory basis of difference in the organization of gene networks of sea stars and sea urchins. *Dev. Biol.* **312**, 584-595.
- Hörstadius, S.** (1939). The mechanics of sea urchin development, studied by operative methods. *Biol. Rev.* **14**, 132-179.
- Illies, M. R., Peeler, M. T., Dechtiaruk, A. M. and Etensohn, C. A.** (2002). Identification and developmental expression of new biomineralization proteins in the sea urchin *Strongylocentrotus purpuratus*. *Dev. Genes Evol.* **212**, 419-431.
- Kawasaki, K. and Weiss, K. M.** (2006). Evolutionary genetics of vertebrate tissue mineralization: the origin and evolution of the secretory calcium-binding phosphoprotein family. *J. Exp. Zool. B Mol. Dev. Evol.* **306**, 295-316.
- Kitamura, K., Nishimura, Y., Kubotera, N., Higuchi, Y. and Yamaguchi, M.** (2002). Transient activation of the *micro1* homeobox gene family in the sea urchin (*Hemicentrotus pulcherrimus*) micromere. *Dev. Genes Evol.* **212**, 1-10.
- Koide, T., Hayata, T. and Cho, K. W. Y.** (2005). *Xenopus* as a model system to study transcriptional gene regulatory networks. *Proc. Natl. Acad. Sci. USA* **102**, 4943-4948.
- Langelan, R. E. and Whiteley, A. H.** (1985). Unequal cleavage and the differentiation of echinoid primary mesenchyme. *Dev. Biol.* **109**, 464-479.
- Leaf, D. S., Anstrom, J. A., Chin, J. E., Harkey, M. A., Showman, R. M. and Raff, R. A.** (1987). Antibodies to a fusion protein identify a cDNA clone encoding msp130, a primary mesenchyme-specific cell surface protein of the sea urchin embryo. *Dev. Biol.* **121**, 29-40.
- Lee, Y. H., Britten, R. J. and Davidson, E. H.** (1999). SM37, a skeletogenic gene of the sea urchin embryo linked to the SM50 gene. *Dev. Growth Differ.* **41**, 303-312.
- Livingston, B. T. and Wilt, F. H.** (1989). Lithium evokes expression of vegetal-specific molecules in the animal blastomeres of sea urchin embryos. *Proc. Natl. Acad. Sci. USA* **86**, 3669-3673.
- Livingston, B. T., Killian, C. E., Wilt, F., Cameron, A., Landrum, M. J., Ermolaeva, O., Sapojnikov, V., Maglott, D. R., Buchanan, A. M. and Etensohn, C. A.** (2006). A genome-wide analysis of biomineralization-related proteins in the sea urchin *Strongylocentrotus purpuratus*. *Dev. Biol.* **300**, 335-348.
- Makabe, K. W., Kirchhamer, C. V., Britten, R. J. and Davidson, E. H.** (1995). Cis-regulatory control of the SM50 gene, an early marker of skeletogenic lineage specification in the sea urchin embryo. *Development* **121**, 1957-1970.
- McClay, D. R. and Logan, C. Y.** (1996). Regulative capacity of the archenteron during gastrulation in the sea urchin. *Development* **122**, 607-616.
- Minokawa, T., Hamaguchi, Y. and Amemiya, S.** (1997). Skeletogenic potential of induced secondary mesenchyme cells derived from presumptive ectoderm in echinoid embryos. *Dev. Genes Evol.* **206**, 472-476.
- Minokawa, T., Wikramanayake, A. H. and Davidson, E. H.** (2005). Cis-regulatory inputs of the *wnt8* gene in the sea urchin endomesoderm network. *Dev. Biol.* **288**, 545-558.
- Munro, E., Robin, F. and Lemaire, P.** (2006). Cellular morphogenesis in ascidians: how to shape a simple tadpole. *Curr. Opin. Genet. Dev.* **16**, 399-405.
- Nakano, H., Hibino, T., Oji, T., Hara, Y. and Amemiya, S.** (2003). Larval stages of a living sea lily (stalked crinoid echinoderm). *Nature* **421**, 158-160.
- Nishimura, Y., Sato, T., Morita, Y., Yamazaki, A., Akasaka, K. and Yamaguchi, M.** (2004). Structure, regulation, and function of *micro1* in the sea urchin *Hemicentrotus pulcherrimus*. *Dev. Genes Evol.* **214**, 525-536.
- Niwa, H.** (2007). Open conformation chromatin and pluripotency. *Genes Dev.* **21**, 2671-2676.
- Ochiai, H., Sakamoto, N., Momiyama, A., Akasaka, K. and Yamamoto, T.** (2008). Analysis of cis-regulatory elements controlling spatio-temporal expression of T-brain gene in sea urchin, *Hemicentrotus pulcherrimus*. *Mech. Dev.* **125**, 2-17.
- Oliveri, P. and Davidson, E. H.** (2004). Gene regulatory network analysis in sea urchin embryos. *Methods Cell Biol.* **74**, 775-794.
- Oliveri, P. and Davidson, E. H.** (2007). Development: built to run, not fail. *Science* **315**, 1510-1511.
- Oliveri, P., Carrick, D. M. and Davidson, E. H.** (2002). A gene regulatory network that directs micromere specification in the sea urchin embryo. *Dev. Biol.* **246**, 209-228.
- Oliveri, P., Davidson, E. H. and McClay, D. R.** (2003). Activation of *pmar1* controls specification of micromeres in the sea urchin embryo. *Development* **126**, 345-357.
- Oliveri, P., Walton, K. D., Davidson, E. H. and McClay, D. R.** (2006). Repression of mesodermal fate by *foxa*, a key endoderm regulator of the sea urchin embryo. *Development* **133**, 4173-4181.
- Oliveri, P., Tu, Q. and Davidson, E. H.** (2008). Global regulatory logic for specification of an embryonic cell lineage. *Proc. Natl. Acad. Sci. USA* **105**, 5955-5962.
- Peled-Kamar, M., Hamilton, P. and Wilt, F. H.** (2002). Spicule matrix protein LSM34 is essential for biomineralization of the sea urchin spicule. *Exp. Cell Res.* **272**, 56-61.
- Ransick, A. and Davidson, E. H.** (2006). Cis-regulatory processing of Notch signaling input to the sea urchin glial cells missing gene during mesoderm specification. *Dev. Biol.* **297**, 587-602.
- Revilla-i-Domingo, R., Minokawa, T. and Davidson, E. H.** (2004). R11: a cis-regulatory node of the sea urchin embryo gene network that controls early expression of SpDelta in micromeres. *Dev. Biol.* **274**, 438-451.
- Revilla-i-Domingo, R., Oliveri, P. and Davidson, E. H.** (2007). A missing link in the sea urchin embryo gene regulatory network: *hesC* and the double-negative specification of micromeres. *Proc. Natl. Acad. Sci. USA* **104**, 12383-12388.
- Röttinger, E., Saudemont, A., Duboc, V., Besnardeau, L., McClay, D. and Lepage, T.** (2008). FGF signals guide migration of mesenchymal cells, control skeletal morphogenesis of the skeleton and regulate gastrulation during sea urchin development. *Development* **135**, 353-365.
- Sandmann, T., Girardot, C., Brehme, M., Tongprasit, W., Stolz, V. and Furlong, E. E.** (2007). A core transcriptional network for early mesoderm development in *Drosophila melanogaster*. *Genes Dev.* **21**, 436-449.
- Satou, Y., Satoh, N. and Imai, K. S.** (2008). Gene regulatory networks in the early ascidian embryo. *Biochim. Biophys. Acta* (in press).
- Sauka-Spengler, T. and Bronner-Fraser, M.** (2008). A gene regulatory network orchestrates neural crest formation. *Nat. Rev. Mol. Cell Biol.* **9**, 557-568.
- Schroeder, T. E.** (1981). Development of a "primitive" sea urchin (*Eucidaris tribuloides*): irregularities in the hyaline layer, micromeres, and primary mesenchyme. *Biol. Bull.* **161**, 141-151.
- Sea Urchin Genome Sequencing Consortium** (2006). The genome of the sea urchin *Strongylocentrotus purpuratus*. *Science* **314**, 941-952.

- Sherwood, D. R. and McClay, D. R.** (1999). LvNotch signaling mediates secondary mesenchyme specification in the sea urchin embryo. *Development* **126**, 1703-1713.
- Smith, A. B., Pisani, D., Mackenzie-Dodds, J. A., Stockley, B., Webster, B. L. and Littlewood, D. T. J.** (2006). Testing the molecular clock: molecular and paleontological estimates of divergence times in the echinoidea (Echinodermata). *Mol. Biol. Evol.* **23**, 1832-1851.
- Stathopoulos, A. and Levine, M.** (2005). Genomic regulatory networks and animal development. *Dev. Cell.* **9**, 449-462.
- Sweet, H. C., Gehring, M. and Ettensohn, C. A.** (2002). LvDelta is a mesoderm-inducing signal in the sea urchin embryo and can endow blastomeres with organizer-like properties. *Development* **129**, 1945-1955.
- Vaughn, D. and Strathmann, R. R.** (2008). Predators induce cloning in echinoderm larvae. *Science* **319**, 1503.
- Wilt, F. H. and Ettensohn, C. A.** (2007). The morphogenesis and biomineralization of the sea urchin larval skeleton. In *Handbook of Biomineralization* (ed. E. Bauerlein), pp. 183-210. Weinheim: Wiley-VCH Press.
- Wray, G. A. and McClay, D. R.** (1988). The origin of spicule-forming cells in a "primitive" sea urchin (*Eucidaris tribuloides*) which appears to lack primary mesenchyme cells. *Development* **103**, 305-315.
- Wu, S. Y. and McClay, D. R.** (2007). The Snail repressor is required for PMC ingression in the sea urchin embryo. *Development* **134**, 1061-1070.
- Yamazaki, A., Kawabata, R., Shiomi, K., Amemiya, S., Sawaguchi, M., Mitsunaga-Nakatsubo, K. and Yamaguchi, M.** (2005). The *micro1* gene is necessary and sufficient for micromere differentiation and mid/hindgut-inducing activity in the sea urchin embryo. *Dev. Genes Evol.* **215**, 450-459.
- Zernicka-Goetz, M.** (2006). The first cell-fate decisions in the mouse: destiny is a matter of both chance and choice. *Curr. Opin. Genet. Dev.* **16**, 406-412.